

Technical support: Email: [tsupport@opussolutions.com](mailto:tsupport@opussolutions.com)

Tel:1- 949-387-1010 x225

### Package Contents

- 1 – DCX1.250 Automotive ATX/ITX & AT intelligent DC-DC 250W Power Supply
- 1 - 24 pin ATX power cable with ATX12V power and Drive connectors
- 1 - 2 pin power switch cable.
- 1 - 6 pin DC input main power and IGN pigtail cable.
- 1 - User guide (the one you are reading)

### General Information

DCX1 is an intelligent DC-DC power supply. It monitors and protects the battery from deep discharge. It is designed to power ATX, BTX, ITX motherboards and single board computer systems. DCX1 can also be used to power any Single board computer. System power up and down can be controlled by the vehicle ignition switch output. System shut down can be delayed (from 5 min to 2 hr) after Ignition (ON/OFF) input is turned off. Start up and shutdown voltage can be set or changed using JU1 – jumper position 4 & 5 (refer figure JU1 jumper block setting)

Remote output can be used to turn on/off peripherals such as Radio, head units, LCD Monitor, etc. Remote output turn off can be turned off before or after the shut down delay. This is controlled by JU2 jumper position 7. Remote output turn on can be delayed to prevent thumps in Audio installation. Contact OPUS for proper SW loading. DCX1 is Compatible with 12 or 24 Volt battery system operation. To operate in 24V mode load JU2- position 8 jumper. This will ensure proper low voltage shutdown sequence in the event of low voltage in 24V mode.

### Operating Modes

DCX1 is designed to operate in 4 different modes. The mode settings are determined by the by your specific application and/or by the mother board/ Single board computer. Operating modes are setup using JU2 jumper block positions 9 & 10 Jumpers.

Refer to fig: JU2 jumper setting.

ATX mode with ON / OFF state input: Mother board : ATX power compliant.  
 Requires 5VSB, uses soft power switch pins of mother board to power up the system and PS\_ON signal to control state of main power.  
 System power-up & power down is controlled by **ON/OFF input pin of DCX1 (J1 – pin 3)**.  
 DCX1 PWR-SW (J7) output connected to mother board soft power switch pins (observe correct polarity).  
 PS\_ON input ( PS\_ON signal is part of ATX power connector ).

ATX mode with PB ( momentary ON/OFF push-button switch) for ON/OFF: Mother board : ATX power compliant.  
 Requires 5VSB, uses soft power switch pins of mother board to power up the system and PS\_ON signal to control state of main power.  
 System power-up & power down is controlled by **front panel soft ON/OFF Push-Button switch** (Front panel push button switch is connected to Mother board Soft power switch pins).  
 DCX1 PWR-SW (J7) output: no connection.  
 PS\_ON input ( PS\_ON signal is part of ATX power connector ).

Sub ATX mode: Mother board : Partially ATX power compliant .  
 May Require 5VSB or 12V SB, uses soft power switch pins of mother board to power up the system and **PS\_ON signal is NOT used**.  
 System power-up & power down is controlled by **ON/OFF input pin of DCX1 (J1 – pin 3)**.  
 DCX1 PWR-SW (J7) output connected to mother board soft power switch pins (observe correct polarity).  
 PS\_ON signal is not used

AT mode: Mother board : AT power compliant.  
 Does Requires 5VSB, Does not have soft power switch pins of mother board to power up the system and does not use PS\_ON signal to control state of main power.  
 System power-up & power down is controlled by **ON/OFF input pin of DCX1 (J1 – pin 3)**.  
 DCX1 applies power to the system/ load when ON/OFF input is connected to battery voltage. Turns off the power to the load when ON/OFF input is disconnected from the battery voltage.

**General wiring guidelines**

Use a dedicated #12 AWG wire to connect the unit to the battery. If Battery wire length is more than 10 feet then use next thicker wire gauge.

Note: Do not share power cable with other equipment. It is highly recommended to run a separate pair of fused power cable to the PC. This eliminates the noise injection from other equipments that share power.

Use #18 AWG wire for on/off input.

**Testing the PC with DC-DC Power supply installed for proper operation**

Power-up the computer by Turning the Ignition switch on (starting the vehicle) or toggling the switch on. The Green Status LED should light up constantly and the computer should power up normally.

**(Note: After connecting the power connector to the power supply, wait for DC-DC to blink twice before turning on the IGN/ ON-OFF switch input. This procedure is required every time the power is applied to the DC-DC main power (yellow) leads.)**

1. Open any application and test for normal operation then close the application.
2. Turn off the computer by turning the ignition switch off. Within 5-10 Sec. the PC should start to go into Standby or shut down mode and the Green status light should go back to the idle/standby blink rate.
4. Wait about 10 seconds and Turn on the Ignition switch again. The computer should power up normally.
5. Open an application for Standby mode testing. Use the application as you would normally.
6. Turn off the computer by turning the ignition switch off. The computer should go into Standby, Hibernate or Shut down mode, as configured in the operating system.
7. Repeat steps 4 to 6 for all applications that are used in your computer.

Note: All applications software must be checked for proper Standby mode operation.

If any application has problem going into Standby mode then the operating system must be configured for Shutdown

## DC-DC power supply Connectors

### J1 - Input Power, On/Off and Remote connector

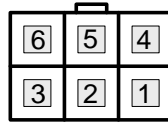

Connector type used: Molex: 39-30-1060  
Mating connector type: Molex: 39-01-2060

Pin#	Function	Description
1	GND	Power Ground (Input - BLK)
2	GND	Power Ground (Input - BLK)
3	ON/OFF	On/Off or ACC (Input - RED)

Pin#	Function	Description
4	+BATT	Battery (Input - YEL)
5	+BATT	Battery (Input - YEL)
6	RMT	Remote On/Off (Output - BLU)

RMT - This output can be used to turn ON/OFF the remote devices such as Audio amplifier, External DVD, Camera, monitor, etc. Remote turn ON delay is set by JU2 – 7 & 8 jumper positions.

### J7 – Power-Switch connector

Pin#	Function	Description
1	PWR-SW-	Power-Switch - (Output - WHT)
2	PWR-SW+	Power-Switch + (Output - GRN)



2 + Connector type used: JST: B/S 2B-PH-K-S  
1 - Mating connector type: JST: PHR-2

Connect to Motherboard or SBC power switch pins. OBSERVE pin polarity for proper operation

### J6 – PS-ON\* signal and Stand-by Power connector

Pin#	Function	Description
1	5V STBY	+5V Stand-by power (output - PUR)
2	PS-ON*	Powersupply ON* (input - BLU)
3	GND	Ground - (BLK)

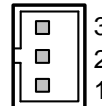

3 Connector type used: JST: B/S 3B-PH-K-S  
2 Mating connector type: JST: PHR-3  
1

Factory default is ATX mode operation. For AT mode operation: Short Pin 2 to pin 3 with a 2mm shorting jumper.

### J9 – ATX / BTX Power connector

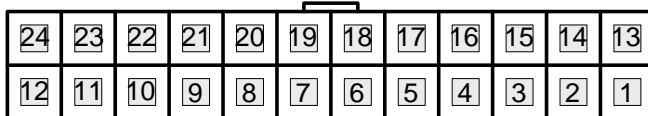

Connector type used: Molex: 39-28-1243  
Mating connector type: Molex: 39-01-2240

Pin#	Function	Description
1	+3.3V	+3.3V (Output - ORN)
2	+3.3V	+3.3V (Output - ORN)
3	GND	Power Ground (Return - BLK)
4	+5V	+5V (Output - RED)
5	GND	Power Ground (Return - BLK)
6	+5V	+5V (Output - RED)
7	GND	Power Ground (Return - BLK)
8	PWR-GD	Power-Good (Output - GRY)
9	+5V STBY	+5V Stand-by (Output - PUR)
10	+12V	+12V (Output - YEL)
11	+12V	+12V (Output - YEL)
12	+3.3VS	+3.3VS (Input - ORN)

Pin#	Function	Description
13	+3.3V	+3.3V (Output - ORN)
14	-12V	-12V (Output - BLU)
15	GND	Power Ground (Return - BLK)
16	PS-ON*	Power supply -ON (Input - GRN)
17	GND	Power Ground (Return - BLK)
18	GND	Power Ground (Return - BLK)
19	GND	Power Ground (Return - BLK)
20	nc	No connection
21	+5V	+5V (Output - RED)
22	+5V	+5V (Output - RED)
23	+5V	+5V (Output - RED)
24	GND	Power Ground (Return - BLK)

### J8 – ATX 12V Power connector

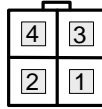

Connector type used: Molex: 39-30-1040  
Mating connector type: Molex: 39-01-2040

Pin#	Function	Description
1	GND	Power Ground (Output - BLK)
2	GND	Power Ground (Output - BLK)

Pin#	Function	Description
3	12V	+12V Output (Output - YEL)
4	12V	+12V Output (Output - YEL)

### J8A – Auxiliary Power connector

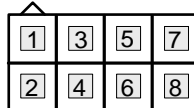

Connector type used: JST: B 8B-PHDSS  
Mating connector type: JST: PHDR-08VS

Pin#	Function	Description
1	+12V	+12V Output (Output - YEL)
3	GND	Power Ground (Return - BLK)
5	GND	Power Ground (Return - BLK)
7	+5V	+5V Output (Output - RED)

Pin#	Function	Description
2	+12V	+12V Output (Output - YEL)
4	GND	Power Ground (Return - BLK)
6	GND	Power Ground (Return - BLK)
8	+5V	+5V Output (Output - RED)

### J2 - On/Off Input Connector (internal)

Pin#	Function	Description
1	Batt	Batt
2	IGN	Ignition input/ ON/OFF input



2 +  
1 -

Connector type used: JST: B/S 2B-PH-K-S  
Mating connector type: JST: PHR-2

Use If Internal Power ON/OFF is Required

### J5 – Fan Power Connector

Pin#	Function	Description
1	GND	Ground - (BLK)
2	12V	12V Power Out ( RED)
3	na	Not used

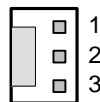

1  
2  
3

Connector type used: Molex: 22-23-5034  
Mating connector type: Molex: 22-01-3037

### J10 - Ignition Sense output TTL

Pin#	Function	Description
1	GND	GND
2	IGN	Ignition Sense Output TTL Lever



2  
1

Connector type used: JST: B/S 2B-PH-K-S  
Mating connector type: JST: PHR-2

Can be used to sense the state of Ignition input to the system

**JU1 – Shut down delay, Start-up & Shut-Dn Voltages, and Stby-On Jumpers**

JU-1 Jumper Block

2mm Shorting Jumper installed

0 = Jumper not Installed  
1 = Jumper Installed

Shut Down Delay (SD) Jumpers				Start-UP & Shut-Down Voltage Jumpers				Stand-by Power ON/OFF Jumper		
Psn #	1	2	3	Psn #	4	5	Psn#	10	Psn #	6
-	SD Dely			-	Start-UP	Shut-Down	-	Stand-by Power state		
	Time				Voltage	Voltage				
0	0	0		0	0		0	0	0 - Stand-by Pwr OFF	
1	0	0		1	0		0	0	1 - Stand-by Pwr ON	
0	1	0		0	1		0	0		
1	1	0		1	1		0	0		
0	0	1		0	0		1	1	If Stand-by Jumper is installed, then, Stand-by voltage is maintained after Power down. Required for Stand-by mode operation only. Stand-by power is removed if the battery voltage goes below Shut-Down voltage.	
1	0	1		1	0		1	1		
0	1	1		0	1		1	1		
1	1	1		1	1		1	1		

**JU2 – Remote-Off State, Operating Voltage Mode and Operating Mode Jumpers**

JU-2 Jumper Block

0 = Jumper not Installed  
1 = Jumper Installed

Remote off state		12V / 24V mode operation		Operating Mode	
Psn #	7	Psn #	8	Psn #	9 10
0	- After SD Delay	0	- 12V operation	0	0 - ATX
1	- Before SD Delay	1	- 24V operation	1	0 - PB
				0	1 - Sub ATX
				1	1 - AT

**Recommended Installation Steps**

- Step 1. Configure DC-DC JU1 and JU2 jumpers. . Install OPUS DC-DC in the system.
- Step 2. Configure ATX/ ITX motherboard BIOS: Turn off AC power loss auto restart, ACPI: S1 or S3 mode, Push btn: Instant off.
- Step 3. Configure operating system: Power-down, hibernate or Stand-by mode.
- Step 4. Test the PC for proper operation. If all passes then, configure the DC-DC shut down delay jumpers if required.

Suggestion: Configure and test system with a standard AC- DC ATX power supply first. Then switch over to OPUS DC-DC power supply.

**DC-DC Application Example**

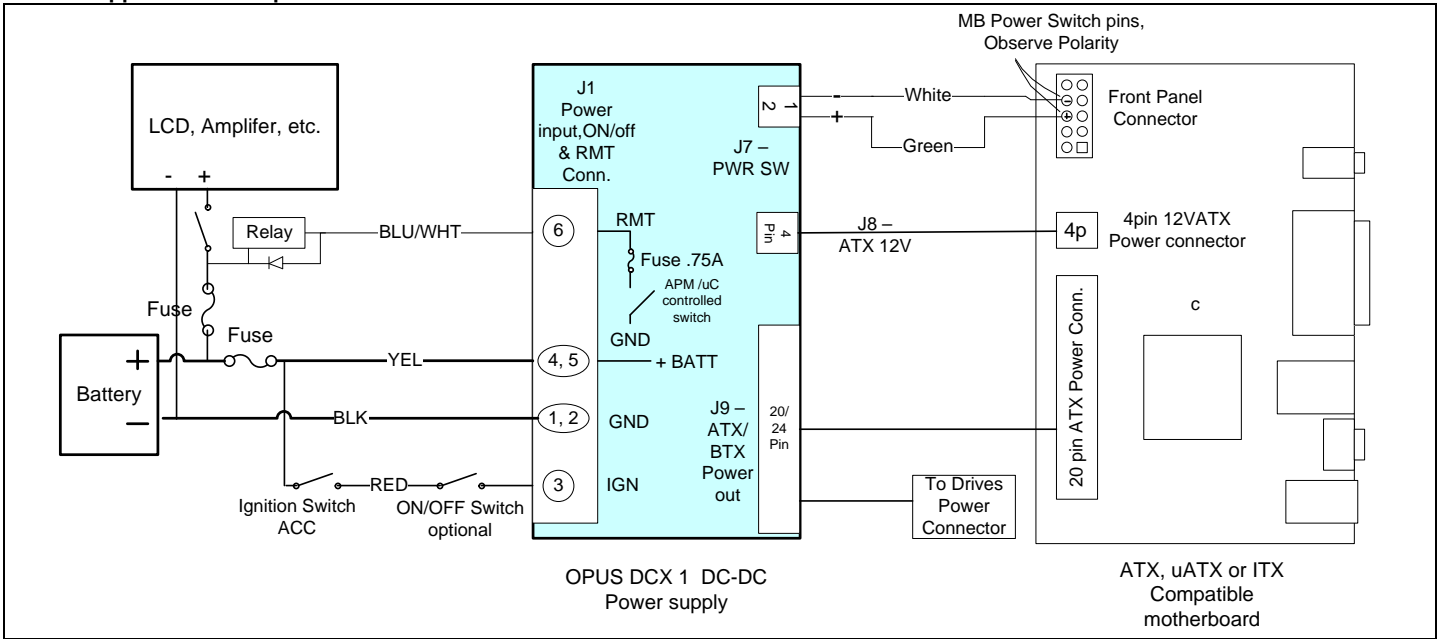

**DCX 1 DC-DC PCB Dimensions**

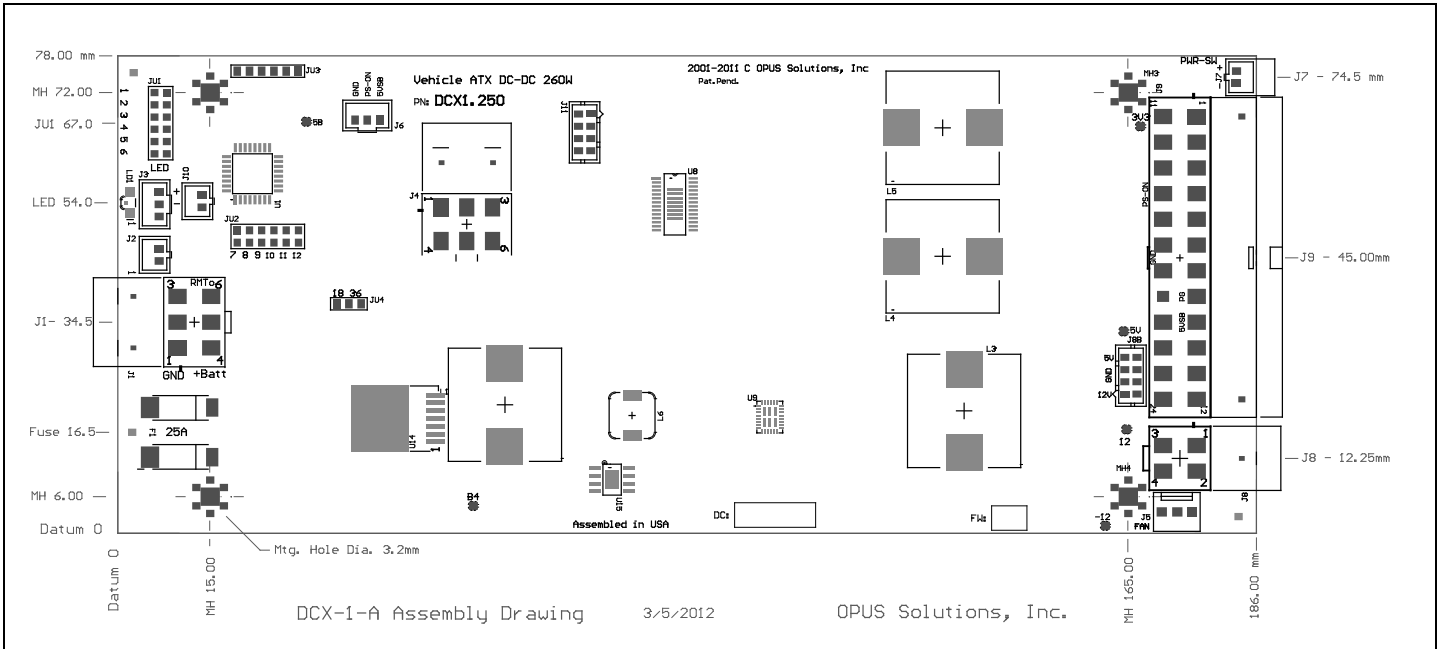

## Trouble shooting guide

*Computer does not turn on?*

Check to make sure that battery and ON-OFF pins are connected to DC-DC Power Supply connector.

*Computer does not turn off when the ignition is turned off!*

Check the Green LED state

### Interpreting the Green Status LED light flashing

0.1 sec ON and 5 Sec OFF Approx.: DC-DC power supply is in Idle or stand-by state.

On constantly      The PC is powered and the PC should be operating.

### Error Flashes

### Reason

1 Flash  
(every 10 Sec.)

Battery voltage is below normal operating range.  
Voltage set by JU1 – 4, 5

2 Flashes

The computer power up sequence failed. Reasons:

- Check the wiring of the two wire power-switch cable from power supply connector J9 to power switch pins on the ATX motherboard. If connected properly check the polarity of the power switch pins, may be reversed.
- Check ATX mother board bios settings.
- Locked up motherboard or software crash.
- Faulty DC-DC power supply.

3 Flashes

Power supply output voltages are out of normal voltage range. Reasons:

- Power supply output is over loaded or shorted.
- Faulty DC-DC power supply.

4 Flashes

Power down, stand-by or hibernate sequence failed. Reasons:

- Check the wiring of the two wire power-switch cable from power supply connector J9 to power switch pins on the ATX motherboard. If connected properly check the polarity of the power switch pins, may be reversed.
- Check ATX motherboard bios settings.
- Check if ACPI function is enabled in the power management BIOS setup. Make sure ACPI drivers are installed in the operating system.
- Check if application is compatible with ACPI mode of operation.
- Locked up motherboard or software crash
- Faulty DC-DC power supply